

P1-Series User Guide

P1-Series Setup (TOX)

1. Push & Lock Track Adapter into the Track

- Insert the adapter into the track so that the mechanical key (B) in the adapter aligns with the groove (A) in the track. Rotate the locking lever (C) approximately 90 degrees until it reaches the lock position.
- Use knob (D) to select the circuit the fixture will draw power from.

PSP (US) Type

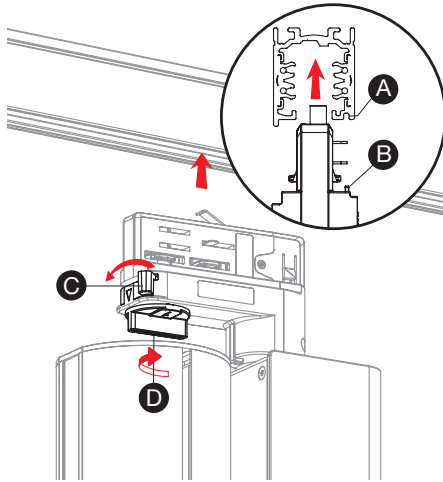

PSP (EU) Type

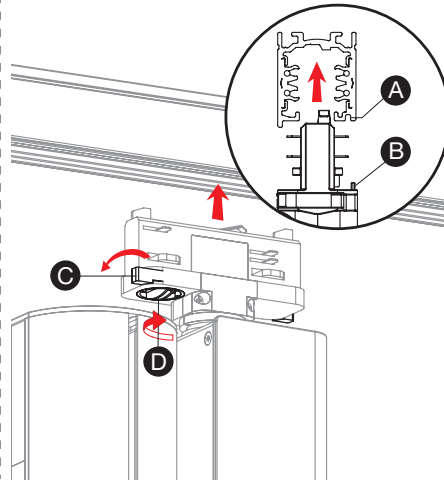

PST Type

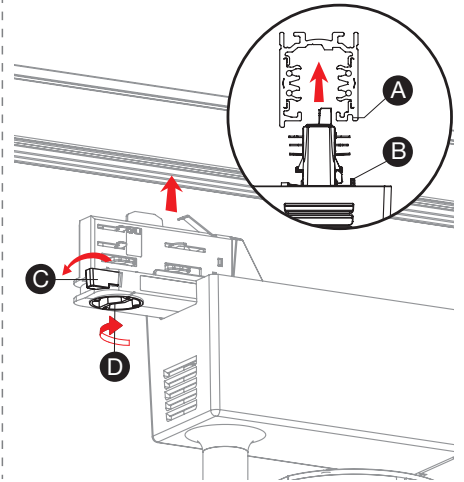

2. Turn on Track Power

- Once assembly is complete, turn on track power and the fixture will light up automatically after 3-5 seconds.
- Remove the screw and open the outer metal cover of the panel. Adjust the DMX settings and values
- PSP Type: Loosen the tilt lock with a hex key, adjust the fixture to the desired angle, then retighten to secure.
- PST Type: Loosen the pan/tilt lock with a hex key, adjust the fixture to the desired angle, then retighten to secure.
- After adjusting all settings, reinstall the metal cover.

PSP Type

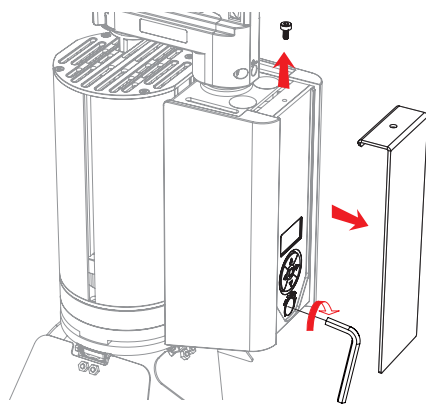

PST Type

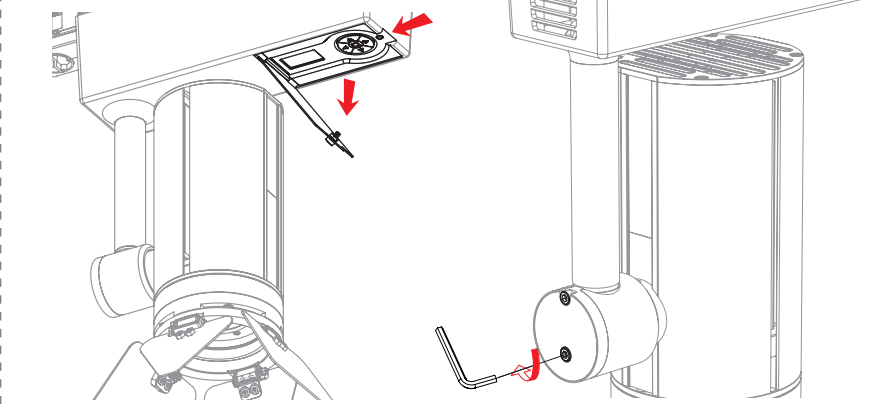

This device complies with Part 15 of the FCC Rules. Operation is subject to the following two conditions:

(1) This device may not cause harmful interference, and (2) this device must accept any interference received, including interference that may cause undesired operation.

070226A

P1-Series Control Panel Guide

Control Panel Overview

PSP Type

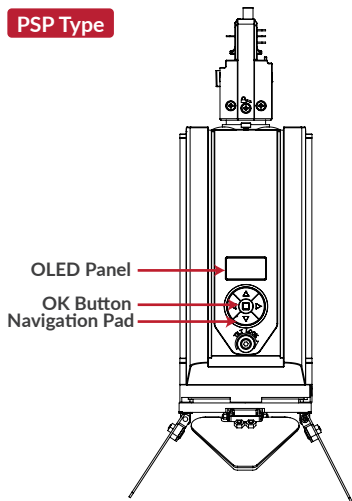

PST Type

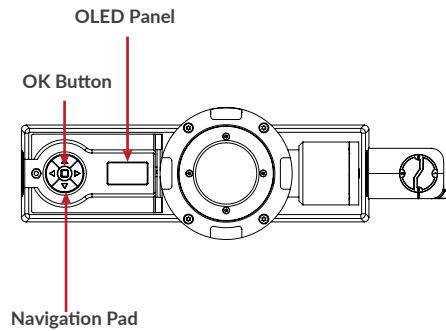

PSM Type

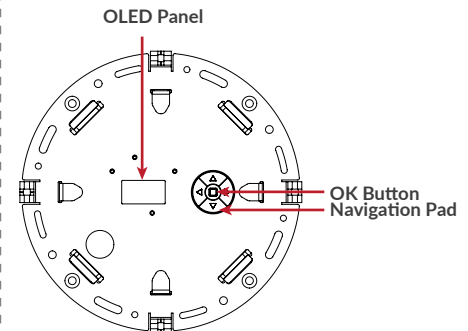

OK Button

- Enter edit mode or quick-jump values.

Navigation Pad

- Access and adjust parameters.

1x Press	2x Press	1x Press
Enter edit mode/ Quick-jump values	Return to upper level	Select/Adjust

DMX Addressing Instruction

Set DMX Address

- 1) Once the fixture is powered on, navigate right until "DMX ADDR." appears.
- 2) Navigate up/down to make adjustments then navigate right to save. Or, double-click the OK button to save and return to upper level.



DMX Signal

When the fixture is not connected to a DMX signal, the screen displays "NO DMX". Once connected, it displays "DMX OK".



Select/Change Mode

- 1) Once the fixture is powered on, navigate right until "MODE" appears, then press the OK button once.



- 2) Navigate right to move through other changeable settings.



- 3) While "MODE" is on screen, navigate up/down until the desired mode is selected, press the OK button to enter.

*A full list of available modes can be found on the webpage.

CCT Mode Operation

1) Intensity "INT" controls the overall fixture output.



2) To adjust the CCT, navigate right until "CCT" is highlighted.

Navigate up/down to make adjustments then navigate right to save. Or, double-click the OK button to save and return to upper level.



3) To adjust the green/magenta shift, navigate right until "GN+" is highlighted.

Navigate up/down to make adjustments then navigate right to save. Or, double-click the OK button to save and return to upper level.



HSI Mode Operation

1) Intensity "INT" controls the overall fixture output.



2) To adjust the HUE, navigate right until "HUE" is highlighted.

Navigate up/down to make adjustments then navigate right to save. Or, double-click the OK button to save and return to upper level.



3) To adjust the saturation, navigate right until "SAT" is highlighted.

Navigate up/down to make adjustments then navigate right to save. Or, double-click the OK button to save and return to upper level.



RGBW Mode Operation

1) Intensity "INT" controls the overall fixture output.



2) To adjust the red value, navigate right until "R" is highlighted.

Navigate up/down to make adjustments then navigate right to save. Or, double-click the OK button to save and return to upper level.



3) Repeat the process to change the rest of the settings.